

GASTRONORM ACCIAIO INOX

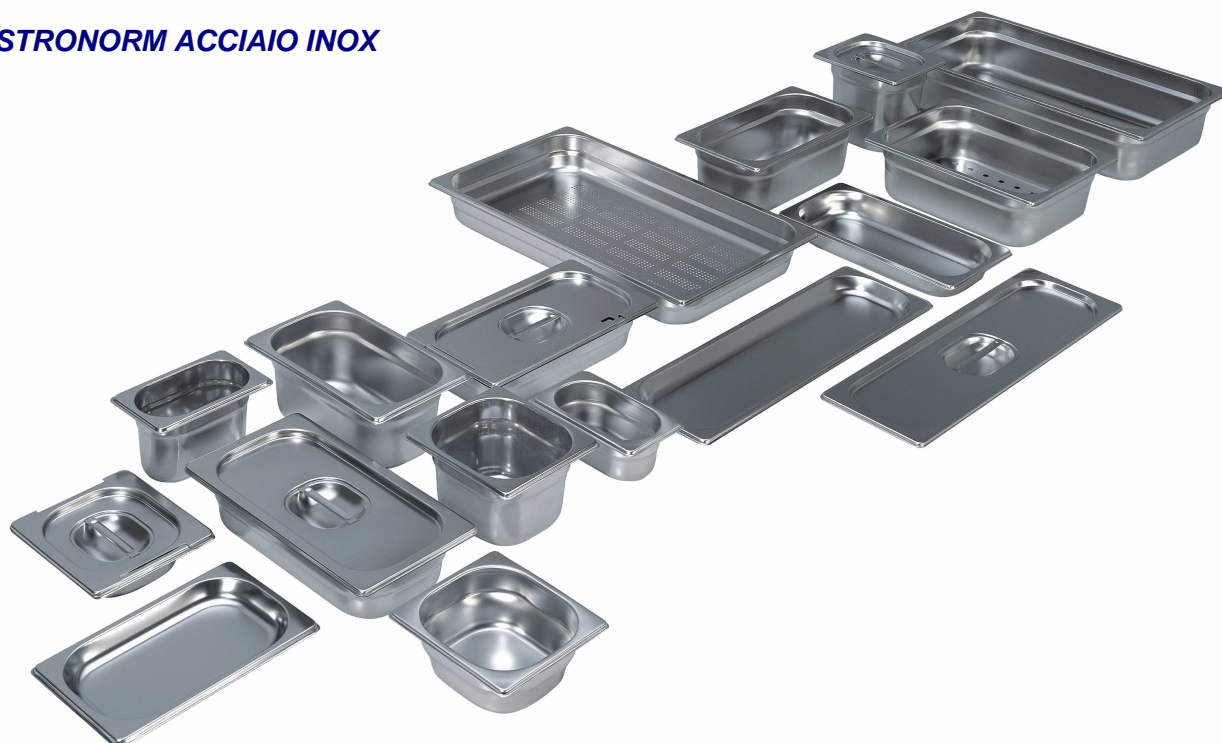

Serie realizzata in acciaio inox 18/10, adatta a qualunque tipo di preparazione (sia caldo che freddo). Totalmente idonea al contatto con gli alimenti, secondo la normativa UE89/109, garantisce una perfetta igienicità grazie anche alla semplicità di pulizia (adatta per andare in lavastoviglie). Le caratteristiche tecniche ne consentono inoltre l'uso in tutte le moderne apparecchiature professionali (friggitrici, forni, armadi refrigerati, ecc.).

BACINELLA (GN 2/1)

Dimensioni (cm.): 65x53xh. 2	Cod.: 110600
Dimensioni (cm.): 65x53xh. 4	Cod.: 110601
Dimensioni (cm.): 65x53xh. 6,5	Cod.: 110602
Dimensioni (cm.): 65x53xh.10	Cod.: 110603
Dimensioni (cm.): 65x53xh.15	Cod.: 110604
Dimensioni (cm.): 65x53xh.20	Cod.: 110605

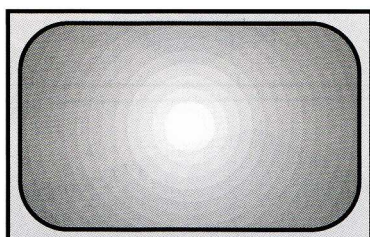
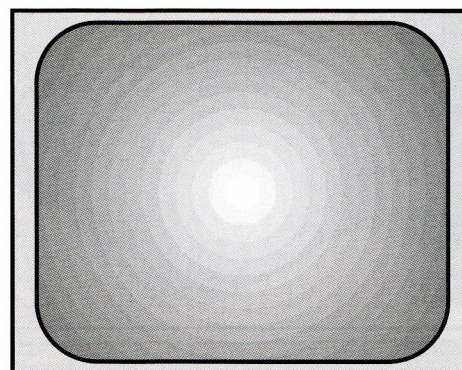

BACINELLA (GN 1/1)

Dimensioni (cm.): 53x32,5xh. 2	Cod.: 110606
Dimensioni (cm.): 53x32,5xh. 4	Cod.: 110607
Dimensioni (cm.): 53x32,5xh. 6,5	Cod.: 110608
Dimensioni (cm.): 53x32,5xh.10	Cod.: 110609
Dimensioni (cm.): 53x32,5xh.15	Cod.: 110610
Dimensioni (cm.): 53x32,5xh.20	Cod.: 110611

BACINELLA (GN 2/3)

Dimensioni (cm.): 35,5x32,5xh. 2 Cod.: **110612**
Dimensioni (cm.): 35,5x32,5xh. 4 Cod.: **110613**
Dimensioni (cm.): 35,5x32,5xh. 6,5 Cod.: **110614**
Dimensioni (cm.): 35,5x32,5xh.10 Cod.: **110615**
Dimensioni (cm.): 35,5x32,5xh.15 Cod.: **110616**
Dimensioni (cm.): 35,5x32,5xh.20 Cod.: **110617**

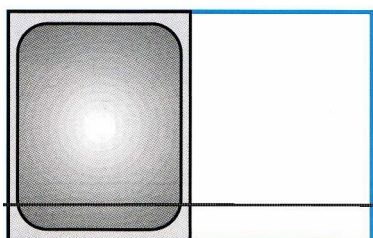
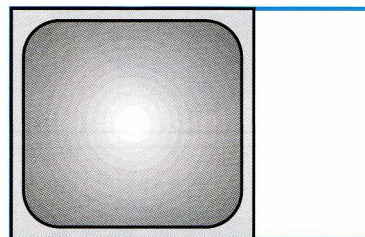

BACINELLA (GN 1/2)

Dimensioni (cm.): 32,5x26,5xh. 2 Cod.: **110618**
Dimensioni (cm.): 32,5x26,5xh. 4 Cod.: **110619**
Dimensioni (cm.): 32,5x26,5xh. 6,5 Cod.: **110620**
Dimensioni (cm.): 32,5x26,5xh.10 Cod.: **110621**
Dimensioni (cm.): 32,5x26,5xh.15 Cod.: **110622**
Dimensioni (cm.): 32,5x26,5xh.20 Cod.: **110623**

BACINELLA (GN 1/3)

Dimensioni (cm.): 32,5x17,5xh. 2 Cod.: **110624**
Dimensioni (cm.): 32,5x17,5xh. 4 Cod.: **110625**
Dimensioni (cm.): 32,5x17,5xh. 6,5 Cod.: **110626**
Dimensioni (cm.): 32,5x17,5xh.10 Cod.: **110627**
Dimensioni (cm.): 32,5x17,5xh.15 Cod.: **110628**
Dimensioni (cm.): 32,5x17,5xh.20 Cod.: **110629**

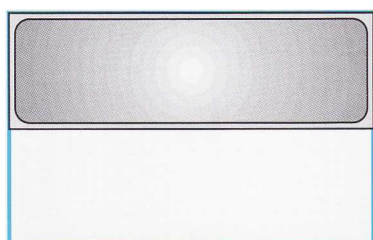
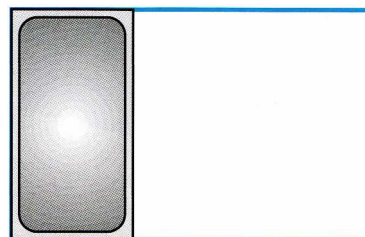

BACINELLA (GN 2/4)

Dimensioni (cm.): 53x16,2xh. 4 Cod.: **110631**
Dimensioni (cm.): 53x16,2xh. 6,5 Cod.: **110632**
Dimensioni (cm.): 53x16,2xh.10 Cod.: **110633**
Dimensioni (cm.): 53x16,2xh.15 Cod.: **110634**

BACINELLA (GN 2/8)

Dimensioni (cm.): 32,5x13xh.15 Cod.: **110635**

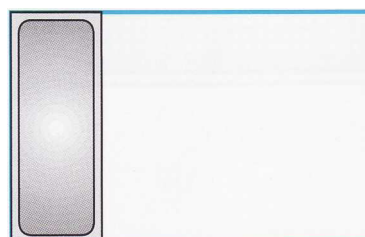

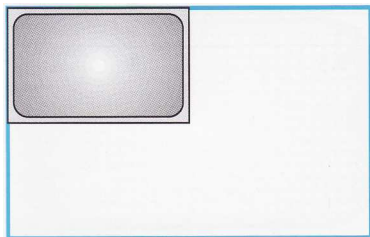

BACINELLA (GN 1/4)

Dimensioni (cm.): 26,4x16,2xh. 2	Cod.: 110636
Dimensioni (cm.): 26,4x16,2xh. 4	Cod.: 110637
Dimensioni (cm.): 26,4x16,2xh. 6,5	Cod.: 110638
Dimensioni (cm.): 26,4x16,2xh.10	Cod.: 110639
Dimensioni (cm.): 26,4x16,2xh.15	Cod.: 110640
Dimensioni (cm.): 26,4x16,2xh.20	Cod.: 110641

BACINELLA (GN 1/6)

Dimensioni (cm.): 17,6x16,2xh. 2	Cod.: 110642
Dimensioni (cm.): 17,6x16,2xh. 4	Cod.: 110643
Dimensioni (cm.): 17,6x16,2xh. 6,5	Cod.: 110644
Dimensioni (cm.): 17,6x16,2xh.10	Cod.: 110645
Dimensioni (cm.): 17,6x16,2xh.15	Cod.: 110646
Dimensioni (cm.): 17,6x16,2xh.20	Cod.: 110647

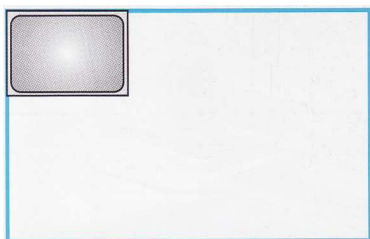
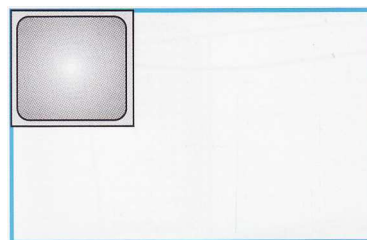

BACINELLA (GN 1/9)

Dimensioni (cm.): 17,6x10,8xh. 6,5	Cod.: 110648
Dimensioni (cm.): 17,6x10,8xh.10	Cod.: 110649

BACINELLA FORATA (GN 2/1)

Dimensioni (cm.): 65x53xh. 2	Cod.: 110650
Dimensioni (cm.): 65x53xh. 4	Cod.: 110651
Dimensioni (cm.): 65x53xh. 6,5	Cod.: 110652
Dimensioni (cm.): 65x53xh.10	Cod.: 110653
Dimensioni (cm.): 65x53xh.15	Cod.: 110654
Dimensioni (cm.): 65x53xh.20	Cod.: 110655

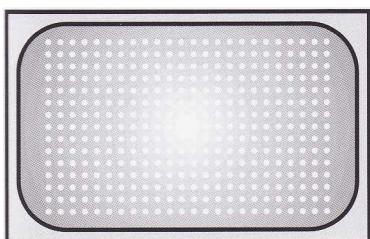
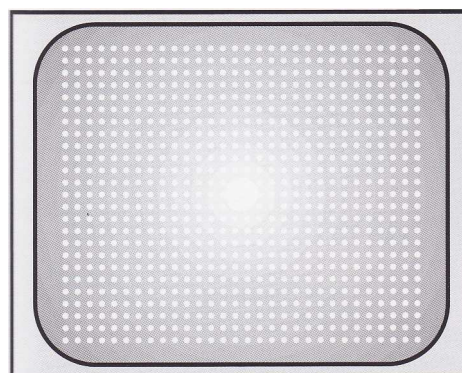

BACINELLA FORATA (GN 1/1)

Dimensioni (cm.): 53x32,5xh. 2	Cod.: 110656
Dimensioni (cm.): 53x32,5xh. 4	Cod.: 110657
Dimensioni (cm.): 53x32,5xh. 6,5	Cod.: 110658
Dimensioni (cm.): 53x32,5xh.10	Cod.: 110659
Dimensioni (cm.): 53x32,5xh.15	Cod.: 110660
Dimensioni (cm.): 53x32,5xh.20	Cod.: 110661

BACINELLA FORATA (GN 1/2)

Dimensioni (cm.): 32,5x26,5xh. 2	Cod.: 110662
Dimensioni (cm.): 32,5x26,5xh. 4	Cod.: 110663
Dimensioni (cm.): 32,5x26,5xh. 6,5	Cod.: 110664
Dimensioni (cm.): 32,5x26,5xh.10	Cod.: 110665
Dimensioni (cm.): 32,5x26,5xh.15	Cod.: 110666
Dimensioni (cm.): 32,5x26,5xh.20	Cod.: 110667

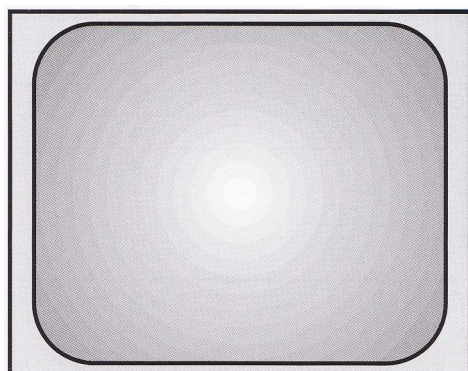
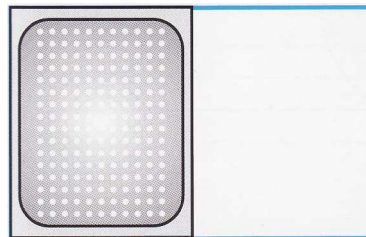

TEGLIA a BORDO PIANO (GN 2/1)

Dimensioni (cm.): 65x53xh. 2	Cod.: 110668
Dimensioni (cm.): 65x53xh. 4	Cod.: 110669
Dimensioni (cm.): 65x53xh. 6,5	Cod.: 110670

TEGLIA a BORDO PIANO (GN 1/1)

Dimensioni (cm.): 53x32,5xh. 2	Cod.: 110671
Dimensioni (cm.): 53x32,5xh. 4	Cod.: 110672
Dimensioni (cm.): 53x32,5xh. 6,5	Cod.: 110673

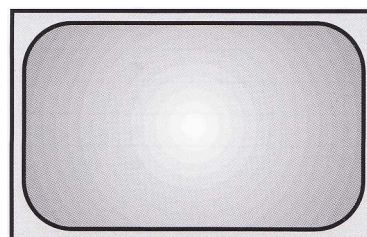

FALSO FONDO FORATO

Dimensioni (cm.): GN 1/1	Cod.: 110674
Dimensioni (cm.): GN 1/2	Cod.: 110675
Dimensioni (cm.): GN 2/1	Cod.: 110676
Dimensioni (cm.): GN 2/3	Cod.: 110677

SEPARATORE

Dimensioni (cm.): 32,5	Cod.: 110678
Dimensioni (cm.): 53	Cod.: 110679





COPPIA MANIGLIE CASCANTI

Cod.: 110779



COPERCHIO INOX

Dimensioni (cm.): GN 1/1	Cod.: 110680
Dimensioni (cm.): GN 1/2	Cod.: 110681
Dimensioni (cm.): GN 1/3	Cod.: 110682
Dimensioni (cm.): GN 1/4	Cod.: 110683
Dimensioni (cm.): GN 1/6	Cod.: 110684
Dimensioni (cm.): GN 1/9	Cod.: 110685
Dimensioni (cm.): GN 2/3	Cod.: 110686
Dimensioni (cm.): GN 2/4	Cod.: 110687
Dimensioni (cm.): GN 2/8	Cod.: 110688

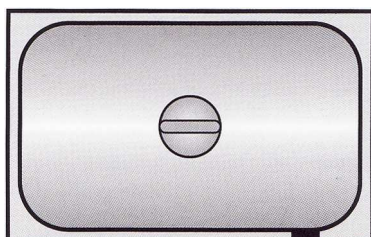
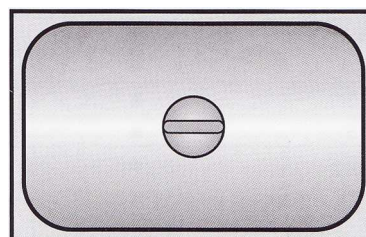

COPERCHIO INOX (con SPACCO MESTOLO)

Dimensioni (cm.): GN 1/3	Cod.: 110691
Dimensioni (cm.): GN 1/4	Cod.: 110692
Dimensioni (cm.): GN 1/6	Cod.: 110693
Dimensioni (cm.): GN 2/3	Cod.: 110694

COPERCHIO INOX (con SPACCO MANIGLIE)

Dimensioni (cm.): GN 1/1	Cod.: 110695
Dimensioni (cm.): GN 1/2	Cod.: 110696
Dimensioni (cm.): GN 1/3	Cod.: 110697
Dimensioni (cm.): GN 1/6	Cod.: 110699
Dimensioni (cm.): GN 2/3	Cod.: 110700

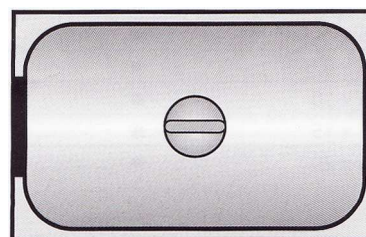

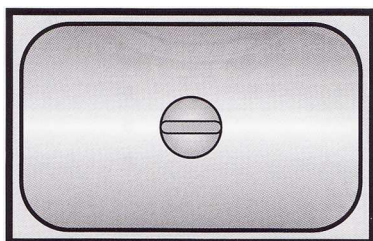

COPERCHIO INOX (con GUARNIZIONE STAGNA)

Dimensioni (cm.): GN 1/1	Cod.: 110701
Dimensioni (cm.): GN 1/2	Cod.: 110702
Dimensioni (cm.): GN 1/3	Cod.: 110703
Dimensioni (cm.): GN 1/4	Cod.: 110704
Dimensioni (cm.): GN 1/6	Cod.: 110705

COPERCHIO INOX (con SPACCO MANIGLIE e GUARNIZIONE STAGNA)

Dimensioni (cm.): GN 1/1	Cod.: 110706
Dimensioni (cm.): GN 1/2	Cod.: 110707

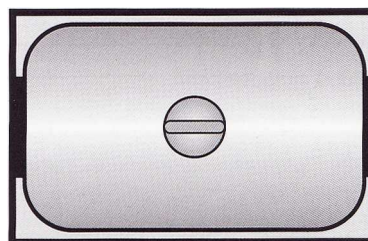

COPERCHIO INOX (con SPACCO MANIGLIE e MESTOLO)

Dimensioni (cm.): GN 1/1	Cod.: 110708
Dimensioni (cm.): GN 1/2	Cod.: 110709
Dimensioni (cm.): GN 1/3	Cod.: 110710
Dimensioni (cm.): GN 2/3	Cod.: 110711

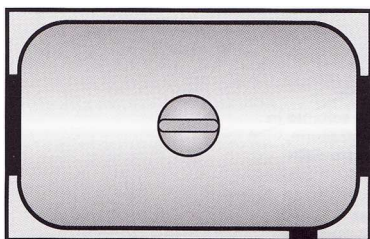

TEGLIA SMALTATA GASTRONORM

TEGLIA SMALTATA GN 1/1

Dimensioni (cm.): 53x32,5xh. 2	Cod.: 4432202
Dimensioni (cm.): 53x32,5xh. 4	Cod.: 4432204
Dimensioni (cm.): 53x32,5xh. 6,5	Cod.: 4432206



GASTRONORM POLICARBONATO



Serie realizzata in policarbonato con caratteristiche di robustezza ed indeformabilità, che rende le vaschette infrangibili. La totale trasparenza del materiale (corredata da una scala graduata) facilitano tutte le operazioni di stoccaggio, permettendo l'immediata identificazione del contenuto e il rapido controllo della sua quantità. Sono completamente idonee per qualunque tipo di preparazione a freddo e sopportano il calore fino a 99°C. Adatti anche per l'utilizzo nella cottura nel microonde. Lavabili in lavastoviglie.

BACINELLA (GN 2/1)

Dimensioni (cm.): 65x53xh.20

Cod.: **110712**

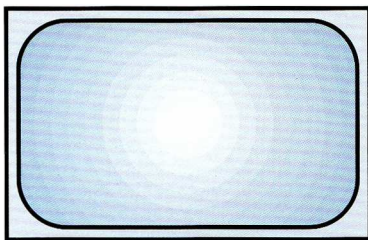
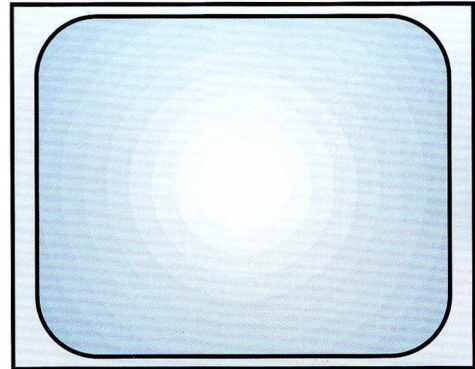

BACINELLA (GN 1/1)

Dimensioni (cm.): 53x32,5xh. 6,5

Cod.: **110713**

Dimensioni (cm.): 53x32,5xh.10

Cod.: **110714**

Dimensioni (cm.): 53x32,5xh.15

Cod.: **110715**

Dimensioni (cm.): 53x32,5xh.20

Cod.: **110716**

BACINELLA (GN 1/2)

Dimensioni (cm.): 32,5x26,5xh. 6,5

Cod.: **110717**

Dimensioni (cm.): 32,5x26,5xh.10

Cod.: **110718**

Dimensioni (cm.): 32,5x26,5xh.15

Cod.: **110719**

Dimensioni (cm.): 32,5x26,5xh.20

Cod.: **110720**

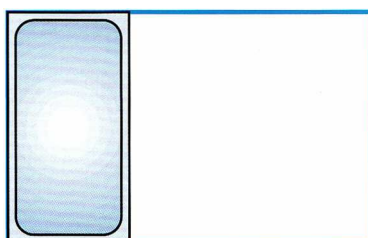
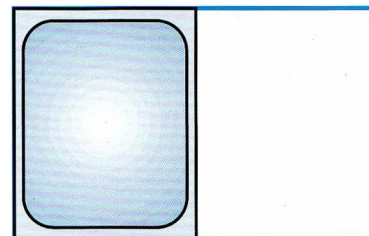

BACINELLA (GN 1/3)

Dimensioni (cm.): 32,5x17,5xh. 6,5

Cod.: **110721**

Dimensioni (cm.): 32,5x17,5xh.10

Cod.: **110722**

Dimensioni (cm.): 32,5x17,5xh.15

Cod.: **110723**

Dimensioni (cm.): 32,5x17,5xh.20

Cod.: **110724**

BACINELLA (GN 1/4)

Dimensioni (cm.): 26,4x16,2xh. 6,5 Cod.: **110725**
 Dimensioni (cm.): 26,4x16,2xh.10 Cod.: **110726**
 Dimensioni (cm.): 26,4x16,2xh.15 Cod.: **110727**
 Dimensioni (cm.): 26,4x16,2xh.20 Cod.: **110728**

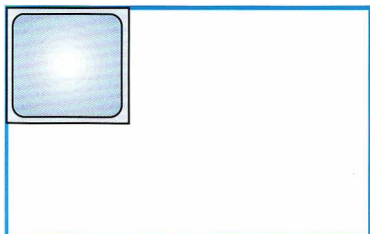
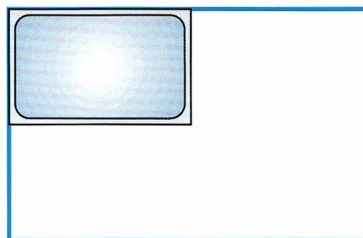

BACINELLA (GN 1/6)

Dimensioni (cm.): 17,6x16,2xh. 6,5 Cod.: **110729**
 Dimensioni (cm.): 17,6x16,2xh.10 Cod.: **110730**
 Dimensioni (cm.): 17,6x16,2xh.15 Cod.: **110731**
 Dimensioni (cm.): 17,6x16,2xh.20 Cod.: **110732**

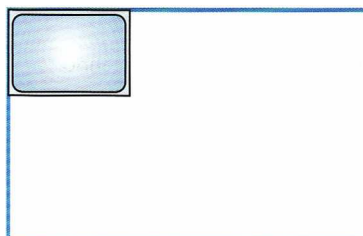

BACINELLA (GN 1/9)

Dimensioni (cm.): 17,6x10,8xh. 6,5 Cod.: **110733**
 Dimensioni (cm.): 17,6x10,8xh.10 Cod.: **110734**

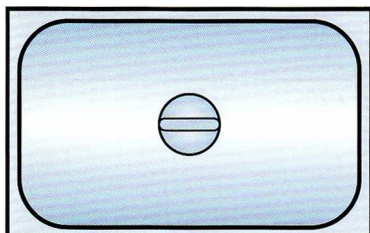

COPERCHIO in POLICARBONATO

Dimensioni (cm.): GN 2/1 Cod.: **110735**
 Dimensioni (cm.): GN 1/1 Cod.: **110736**
 Dimensioni (cm.): GN 1/2 Cod.: **110737**
 Dimensioni (cm.): GN 1/3 Cod.: **110738**
 Dimensioni (cm.): GN 1/4 Cod.: **110739**
 Dimensioni (cm.): GN 1/6 Cod.: **110740**
 Dimensioni (cm.): GN 1/9 Cod.: **110741**

COPERCHIO in POL.TO (a TENUTA ERMETICA)

Dimensioni (cm.): GN 1/1 Cod.: **110742**
 Dimensioni (cm.): GN 1/2 Cod.: **110743**
 Dimensioni (cm.): GN 1/3 Cod.: **110744**
 Dimensioni (cm.): GN 1/4 Cod.: **110745**
 Dimensioni (cm.): GN 1/6 Cod.: **110746**
 Dimensioni (cm.): GN 1/9 Cod.: **110747**

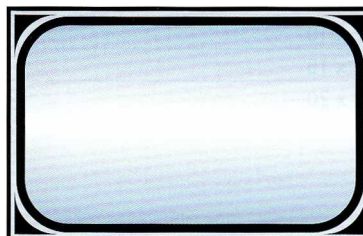

FALSO FONDO FORATO in POLICARBONATO

Dimensioni (cm.): GN 2/1 Cod.: **110748**
 Dimensioni (cm.): GN 1/1 Cod.: **110749**
 Dimensioni (cm.): GN 1/2 Cod.: **110750**

GASTRONORM POLIPROPILENE



Serie realizzata in polipropilene è ideale per la preparazioni a freddo, con caratteristiche del materiale più morbido rispetto al policarbonato. Composta da materiale non ideale per le preparazioni a caldo, ma la trasparenza garantisce una facile identificazione del contenuto. Particolarmente indicata per lo stoccaggio e la conservazione a freddo.

BACINELLA (GN 1/1)

Dimensioni (cm.): 53x32,5xh. 6,5	Cod.: 110751
Dimensioni (cm.): 53x32,5xh.10	Cod.: 110752
Dimensioni (cm.): 53x32,5xh.15	Cod.: 110753
Dimensioni (cm.): 53x32,5xh.20	Cod.: 110754

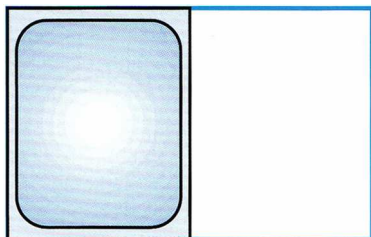
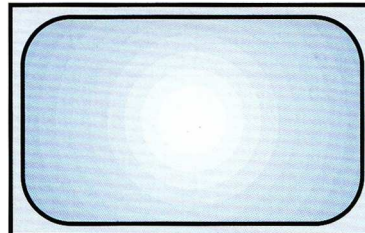

BACINELLA (GN 1/2)

Dimensioni (cm.): 32,5x26,5xh. 6,5	Cod.: 110755
Dimensioni (cm.): 32,5x26,5xh.10	Cod.: 110756
Dimensioni (cm.): 32,5x26,5xh.15	Cod.: 110757
Dimensioni (cm.): 32,5x26,5xh.20	Cod.: 110758

BACINELLA (GN 1/3)

Dimensioni (cm.): 32,5x17,5xh. 6,5	Cod.: 110759
Dimensioni (cm.): 32,5x17,5xh.10	Cod.: 110760
Dimensioni (cm.): 32,5x17,5xh.15	Cod.: 110761
Dimensioni (cm.): 32,5x17,5xh.20	Cod.: 110762

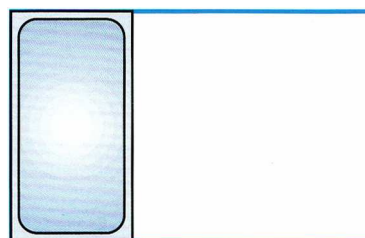

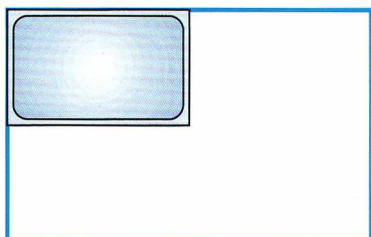

BACINELLA (GN 1/4)

Dimensioni (cm.): 26,4x16,2xh. 6,5 Cod.: **110763**
 Dimensioni (cm.): 26,4x16,2xh.10 Cod.: **110764**
 Dimensioni (cm.): 26,4x16,2xh.15 Cod.: **110765**
 Dimensioni (cm.): 26,4x16,2xh.20 Cod.: **110766**

BACINELLA (GN 1/6)

Dimensioni (cm.): 17,6x16,2xh. 6,5 Cod.: **110767**
 Dimensioni (cm.): 17,6x16,2xh.10 Cod.: **110768**
 Dimensioni (cm.): 17,6x16,2xh.15 Cod.: **110769**
 Dimensioni (cm.): 17,6x16,2xh.20 Cod.: **110770**

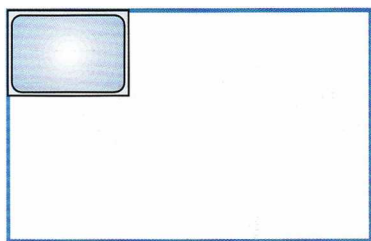
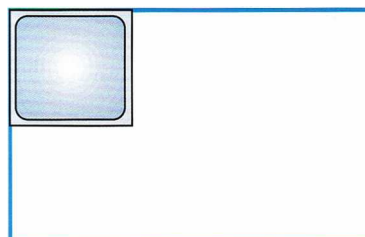

BACINELLA (GN 1/9)

Dimensioni (cm.): 17,6x10,8xh. 6,5 Cod.: **110771**
 Dimensioni (cm.): 17,6x10,8xh.10 Cod.: **110772**

COPERCHI GN in POLIPROPILENE



Neutro



Rosso



Giallo



Blu



Verde

GN 1/1	Cod.: 110773	Cod.: 110773R	Cod.: 110773G	Cod.: 110773B	Cod.: 110773V
GN 1/2	Cod.: 110774	Cod.: 110774R	Cod.: 110774G	Cod.: 110774B	Cod.: 110774V
GN 1/3	Cod.: 110775	Cod.: 110775R	Cod.: 110775G	Cod.: 110775B	Cod.: 110775V
GN 1/4	Cod.: 110776	Cod.: 110776R	Cod.: 110776G	Cod.: 110776B	Cod.: 110776V
GN 1/6	Cod.: 110777	Cod.: 110777R	Cod.: 110777G	Cod.: 110777B	Cod.: 110777V
GN 1/9	Cod.: 110778	Cod.: 110778R	Cod.: 110778G	Cod.: 110778B	Cod.: 110778V