

CESTI SOVRAPPONIBILI

STACKABLE BASKETS
CORBEILLES EMPILABLES
STAPELBARE KÖRBE

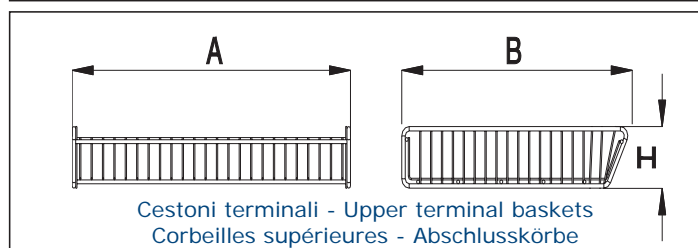
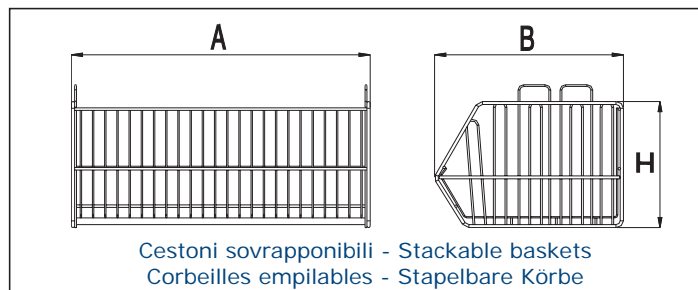
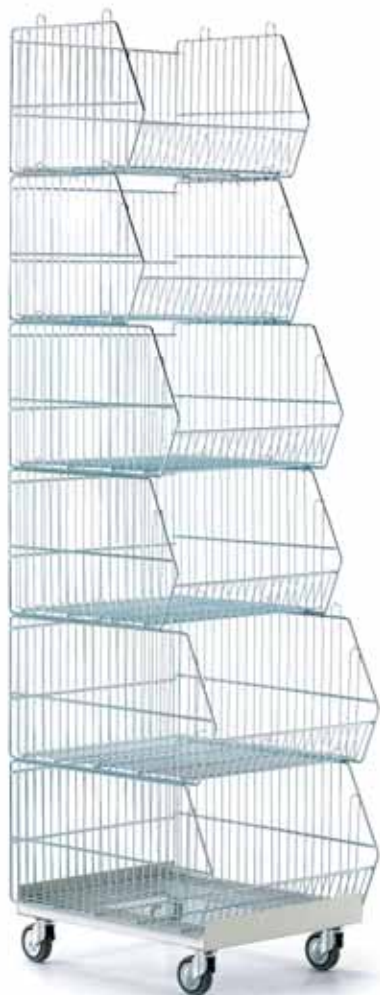

| CODICE - CODE CODE - KODEX | DETTAGLI - DETAILS - DETAILS - DETAIL | | | Portata Capacity Capacité de charge Tragfähigkeit (kg) | Descrizione Description Description Beschreibung |
|-------------------------------|---|-----|-----|--|---|
| | Dimensioni Dimensions Dimensions Abmessungen (mm) | | | | |
| | A | B | H | | |
| 10032L32 | 320 | 350 | 250 | 20 | sovrapponibile - zincato stackable - galvanized empilable - zingué stapelbar - verzinkt |
| 10032L42 | 320 | 400 | 250 | 20 | |
| 10032L52 | 320 | 500 | 250 | 30 | |
| 10032L62 | 320 | 600 | 250 | 30 | |
| 10048L32 | 480 | 350 | 250 | 15 | sovrapponibile - zincato stackable - galvanized empilable - zingué stapelbar - verzinkt |
| 10048L42 | 480 | 400 | 250 | 15 | |
| 10048L52 | 480 | 500 | 250 | 15 | |
| 10048L62 | 480 | 600 | 250 | 25 | |
| 10064P41 | 640 | 400 | 100 | 17 | terminale - zincato upper terminal - galvanized supérieure - zingué abschluss - verzinkt |
| 10064P51 | 640 | 500 | 100 | 23 | |
| 10064P61 | 640 | 600 | 100 | 29 | |

| CODICE - CODE CODE - KODEX | DETTAGLI - DETAILS - DETAILS - DETAIL | | | Portata Capacity Capacité de charge Tragfähigkeit (kg) | Descrizione Description Description Beschreibung | |
|-------------------------------|---|-----|-----|--|--|---|
| | Dimensioni Dimensions Dimensions Abmessungen (mm) | | | | | |
| | A | B | H | | | |
| 10064P43 | 640 | 400 | 300 | 85 | sovrapponibile - zincato stackable - galvanized empilable - zingué stapelbar - verzinkt | |
| 10064P53 | 640 | 500 | 300 | 115 | | |
| 10064P63 | 640 | 600 | 300 | 145 | | |
| 10064P44 | 640 | 400 | 400 | 85 | | |
| 10064P54 | 640 | 500 | 400 | 115 | | |
| 10064P64 | 640 | 600 | 400 | 145 | | |
| 10064P74 | 640 | 700 | 400 | 170 | | |
| 10064P84 | 640 | 800 | 400 | 200 | | |
| 10095P41 | 950 | 400 | 100 | 11 | | terminale - zincato upper terminal - galvanized supérieure - zingué abschluss - verzinkt |
| 10095P51 | 950 | 500 | 100 | 15 | | |
| 10095P61 | 950 | 600 | 100 | 20 | | |

TUTTE LE MISURE SONO ESPRESSE IN mm / ALL MEASUREMENTS IN mm / TOUTES MESURES EN mm / ALLE MAßE IN mm

CESTI SOVRAPPONIBILI

STACKABLE BASKETS CORBEILLES EMPILABLES STAPELBARE KÖRBE

| CODICE - CODE CODE - KODEX | DETTAGLI - DETAILS - DETAILS - DETAIL | | | Descrizione Description Beschreibung |
|-------------------------------|---|--|--|--|
| | Dimensioni Dimensions Dimensions Abmessungen (mm) | Portata Capacity Capacité de charge Tragfähigkeit (kg) | | |

| | A | B | H | |
|----------|-----|-----|-----|---|
| 10095P43 | 950 | 400 | 300 | sovrapponibile - zincato stackable - galvanized empilable - zingué stapelbar - verzinkt pesante - heavy - lourde - schwer |
| 10095P53 | 950 | 500 | 300 | |
| 10095P63 | 950 | 600 | 300 | |
| 10095P44 | 950 | 400 | 400 | |
| 10095P54 | 950 | 500 | 400 | |
| 10095P64 | 950 | 600 | 400 | |
| 10095P74 | 950 | 700 | 400 | |
| 10095P84 | 950 | 800 | 400 | |

| | | | | |
|----------|-----|-----|-----|---|
| 10099P41 | 990 | 400 | 100 | terminale - zincato upper terminal - galvanized supérieure - zingué abschluss - verzinkt |
| 10099P51 | 990 | 500 | 100 | |
| 10099P61 | 990 | 600 | 100 | |
| 10099P43 | 990 | 400 | 300 | sovrapponibile - zincato stackable - galvanized empilable - zingué stapelbar - verzinkt pesante - heavy - lourde - schwer |
| 10099P53 | 990 | 500 | 300 | |
| 10099P63 | 990 | 600 | 300 | |
| 10099P44 | 990 | 400 | 400 | |
| 10099P54 | 990 | 500 | 400 | |
| 10099P64 | 990 | 600 | 400 | |
| 10099P74 | 990 | 700 | 400 | |
| 10099P84 | 990 | 800 | 400 | |

| | | | | |
|----------|------|-----|-----|---|
| 10125P41 | 1250 | 400 | 100 | terminale - zincato upper terminal - galvanized supérieure - zingué abschluss - verzinkt |
| 10125P51 | 1250 | 500 | 100 | |
| 10125P61 | 1250 | 600 | 100 | |

| CODICE - CODE CODE - KODEX | DETTAGLI - DETAILS - DETAILS - DETAIL | | | Descrizione Description Beschreibung |
|-------------------------------|---|--|--|--|
| | Dimensioni Dimensions Dimensions Abmessungen (mm) | Portata Capacity Capacité de charge Tragfähigkeit (kg) | | |

| | A | B | H | |
|----------|------|-----|-----|---|
| 10125P43 | 1250 | 400 | 300 | sovrapponibile - zincato stackable - galvanized empilable - zingué stapelbar - verzinkt pesante - heavy - lourde - schwer |
| 10125P53 | 1250 | 500 | 300 | |
| 10125P63 | 1250 | 600 | 300 | |
| 10125P44 | 1250 | 400 | 400 | |
| 10125P54 | 1250 | 500 | 400 | |
| 10125P64 | 1250 | 600 | 400 | |
| 10125P74 | 1250 | 700 | 400 | |
| 10125P84 | 1250 | 800 | 400 | |

| | | | | |
|----------|------|-----|-----|---|
| 10132P41 | 1320 | 400 | 100 | terminale - zincato upper terminal - galvanized supérieure - zingué abschluss - verzinkt |
| 10132P51 | 1320 | 500 | 100 | |
| 10132P61 | 1320 | 600 | 100 | |
| 10132P44 | 1320 | 400 | 400 | sovrapponibile - zincato stackable - galvanized empilable - zingué stapelbar - verzinkt pesante - heavy - lourde - schwer |
| 10132P54 | 1320 | 500 | 400 | |
| 10132P64 | 1320 | 600 | 400 | |
| 10132P74 | 1320 | 700 | 400 | |
| 10132P84 | 1320 | 800 | 400 | |

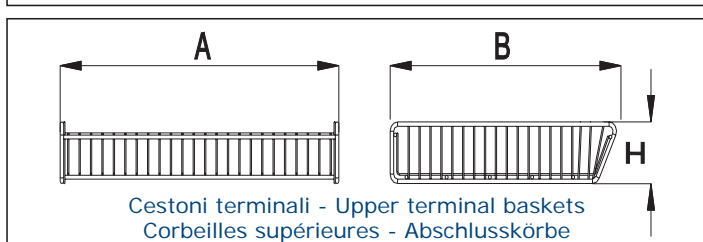
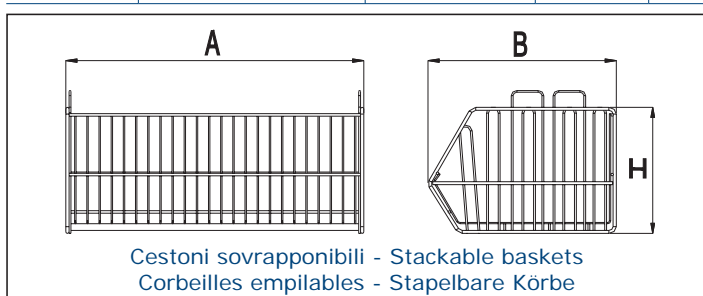

NEI CESTI TERMINALI LA MISURA B REALE E' CIRCA 9 CM IN MENO RISPETTO ALLA NOMINALE
FOR TERMINAL BASKETS, THE REAL DIMENSION B IS 9 CM LESS THAN THE QUOTED ONE
POUR LES CORBEILLES SUPERIEURES, LA MESURE B REELLE EST 9 CM MOINS QUE CELLE NOMINALE
FÜR ABSCHLUSS KÖRBE, DIE RICHTIGE MASSE B IST 9 CM WENIGER ALS DIE NOMINALER

TUTTE LE MISURE SONO ESPRESSE IN mm / ALL MEASUREMENTS IN mm / TOUTES MESURES EN mm / ALLE MAßE IN mm

CESTI IMBOTTIGLIABILI

INSERTABLE BASKETS CORBEILLES EMBOUTEILLABLES EINFÜGBARE KÖRBE



- * 4 supporti per sovrapposizione esclusi
- * 4 supports not included
- * 4 supports pas compris
- * 4 Hältern nicht inbegriffen

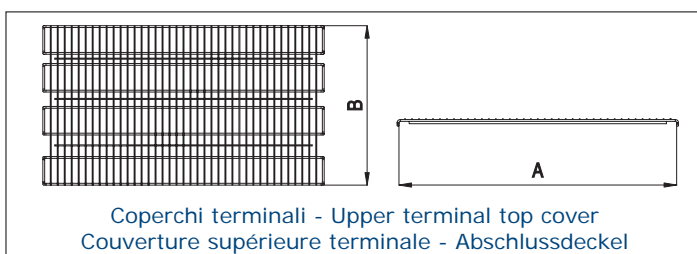
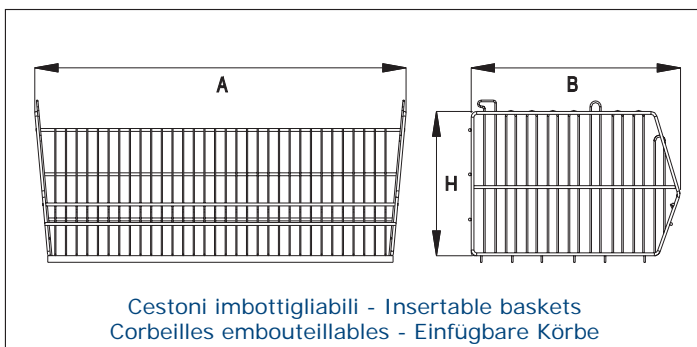

| CODICE - CODE CODE - KODEX | DETTAGLI - DETAILS - DETAILS - DETAIL | | | Descrizione Description Description Beschreibung | |
|-------------------------------|---|---|---|---|--|
| | Dimensioni Dimensions Dimensions Abmessungen (mm) | | | | Portata Capacity Capacité de charge Tragfähigkeit (kg) |
| | A | B | H | | |
| *10064143 | 640 x 400 x 300 | | | 85 | imbottigliabile - zincato insertable - galvanized embouteillable - zingué einfügbar - verzinkt |
| *10096155 | 960 x 500 x 350 | | | 115 | |
| *10096175 | 960 x 700 x 450 | | | 135 | |
| *10105155 | 1050 x 500 x 350 | | | 105 | |
| *10105175 | 1050 x 700 x 450 | | | 125 | |
| *10128155 | 1280 x 500 x 350 | | | 85 | |
| *10128175 | 1280 x 700 x 450 | | | 100 | |
| *10132198 | 1320 x 900 x 800 | | | 125 | |
| 10064743 | 640 x 400 cesti - baskets corbeilles - Körbe H 300 | | | | coperchio terminale - zincato upper terminal top cover - galvanized couverture supérieure terminale - zingué Abschlussdeckel - verzinkt |
| 10096755 | 960 x 500 cesti - baskets corbeilles - Körbe H 350 | | | | |
| 10096775 | 960 x 700 cesti - baskets corbeilles - Körbe H 450 | | | | |
| 10105755 | 1050 x 500 cesti - baskets corbeilles - Körbe H 350 | | | | |
| 10105775 | 1050 x 700 cesti - baskets corbeilles - Körbe H 450 | | | | |
| 10128755 | 1280 x 500 cesti - baskets corbeilles - Körbe H 350 | | | | |
| 10128775 | 1280 x 700 cesti - baskets corbeilles - Körbe H 450 | | | | |



BASI FISSE PER CESTERIA

FIXED BASES FOR BASKETS
SOCLES FIXES POUR CORBEILLES
FESTE BASIS FÜR KÖRBE

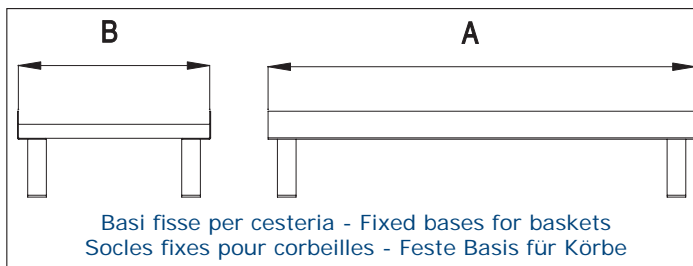

| CODICE - CODE CODE - KODEX | DETTAGLI - DETAILS - DETAILS - DETAIL | | Descrizione Description Description Beschreibung |
|--|---|-----|--|
| | Dimensioni Dimensions Dimensions Abmessungen (mm) | | |
| | A | B | |
| 10032432 | 320 | 350 | basi verniciate color avorio bases ivory coated socles vernis ivoire lackierte elfenbeine Basis RAL 1013 |
| 10032442 | 320 | 400 | |
| 10032452 | 320 | 500 | |
| 10032462 | 320 | 600 | |
| 10048432 | 480 | 350 | basi verniciate color avorio bases ivory coated socles vernis ivoire lackierte elfenbeine Basis RAL 1013 |
| 10048442 | 480 | 400 | |
| 10048452 | 480 | 500 | |
| 10048462 | 480 | 600 | |
| 10064443 | 640 | 400 | basi verniciate color avorio bases ivory coated socles vernis ivoire lackierte elfenbeine Basis RAL 1013 |
| per cesto - for basket - pour corbeille - für Korb H 300 | | | |
| 10064444 | 640 | 400 | |
| per cesto - for basket - pour corbeille - für Korb H 400 | | | |
| 10064453 | 640 | 500 | |
| per cesto - for basket - pour corbeille - für Korb H 300 | | | |
| 10064454 | 640 | 500 | |
| per cesto - for basket - pour corbeille - für Korb H 400 | | | |
| 10064463 | 640 | 600 | |
| per cesto - for basket - pour corbeille - für Korb H 300 | | | |
| 10064464 | 640 | 600 | |
| per cesto - for basket - pour corbeille - für Korb H 400 | | | |
| 10064474 | 640 | 700 | |
| per cesto - for basket - pour corbeille - für Korb H 400 | | | |
| 10064484 | 640 | 800 | |
| per cesto - for basket - pour corbeille - für Korb H 400 | | | |
| 10095443 | 950 | 400 | basi verniciate color avorio bases ivory coated socles vernis ivoire lackierte elfenbeine Basis RAL 1013 |
| per cesto - for basket - pour corbeille - für Korb H 300 | | | |
| 10095444 | 950 | 400 | |
| per cesto - for basket - pour corbeille - für Korb H 400 | | | |
| 10095453 | 950 | 500 | |
| per cesto - for basket - pour corbeille - für Korb H 300 | | | |
| 10095454 | 950 | 500 | |
| per cesto - for basket - pour corbeille - für Korb H 400 | | | |
| 10095463 | 950 | 600 | |
| per cesto - for basket - pour corbeille - für Korb H 300 | | | |
| 10095464 | 950 | 600 | |
| per cesto - for basket - pour corbeille - für Korb H 400 | | | |
| 10095474 | 950 | 700 | |
| per cesto - for basket - pour corbeille - für Korb H 400 | | | |
| 10095484 | 950 | 800 | |
| per cesto - for basket - pour corbeille - für Korb H 400 | | | |

| CODICE - CODE CODE - KODEX | DETTAGLI - DETAILS - DETAILS - DETAIL | | Descrizione Description Description Beschreibung |
|--|---|-----|--|
| | Dimensioni Dimensions Dimensions Abmessungen (mm) | | |
| | A | B | |
| 10099443 | 990 | 400 | basi verniciate color avorio bases ivory coated socles vernis ivoire lackierte elfenbeine Basis RAL 1013 |
| per cesto - for basket - pour corbeille - für Korb H 300 | | | |
| 10099444 | 990 | 400 | |
| per cesto - for basket - pour corbeille - für Korb H 400 | | | |
| 10099453 | 990 | 500 | |
| per cesto - for basket - pour corbeille - für Korb H 300 | | | |
| 10099454 | 990 | 500 | |
| per cesto - for basket - pour corbeille - für Korb H 400 | | | |
| 10099463 | 990 | 600 | |
| per cesto - for basket - pour corbeille - für Korb H 300 | | | |
| 10099464 | 990 | 600 | |
| per cesto - for basket - pour corbeille - für Korb H 400 | | | |
| 10099474 | 990 | 700 | |
| per cesto - for basket - pour corbeille - für Korb H 400 | | | |
| 10099484 | 990 | 800 | |
| per cesto - for basket - pour corbeille - für Korb H 400 | | | |
| 10125443 | 1250 | 400 | basi verniciate color avorio bases ivory coated socles vernis ivoire lackierte elfenbeine Basis RAL 1013 |
| per cesto - for basket - pour corbeille - für Korb H 300 | | | |
| 10125444 | 1250 | 400 | |
| per cesto - for basket - pour corbeille - für Korb H 400 | | | |
| 10125453 | 1250 | 500 | |
| per cesto - for basket - pour corbeille - für Korb H 300 | | | |
| 10125454 | 1250 | 500 | |
| per cesto - for basket - pour corbeille - für Korb H 400 | | | |
| 10125463 | 1250 | 600 | |
| per cesto - for basket - pour corbeille - für Korb H 300 | | | |
| 10125464 | 1250 | 600 | |
| per cesto - for basket - pour corbeille - für Korb H 400 | | | |
| 10125474 | 1250 | 700 | |
| per cesto - for basket - pour corbeille - für Korb H 400 | | | |
| 10125484 | 1250 | 800 | |
| per cesto - for basket - pour corbeille - für Korb H 400 | | | |
| 10132444 | 1320 | 400 | basi verniciate color avorio bases ivory coated socles vernis ivoire lackierte elfenbeine Basis RAL 1013 |
| per cesto - for basket - pour corbeille - für Korb H 400 | | | |
| 10132454 | 1320 | 500 | |
| per cesto - for basket - pour corbeille - für Korb H 400 | | | |
| 10132464 | 1320 | 600 | |
| per cesto - for basket - pour corbeille - für Korb H 400 | | | |
| 10132474 | 1320 | 700 | |
| per cesto - for basket - pour corbeille - für Korb H 400 | | | |
| 10132484 | 1320 | 800 | |
| per cesto - for basket - pour corbeille - für Korb H 400 | | | |

TUTTE LE MISURE SONO ESPRESSE IN mm / ALL MEASUREMENTS IN mm / TOUTES MESURES EN mm / ALLE MAßE IN mm

BASI CON RUOTE PER CESTERIA

WHEELED BASES FOR BASKETS SOCLES ROULANTS POUR CORBEILLES ROLLENBASIS FÜR KÖRBE

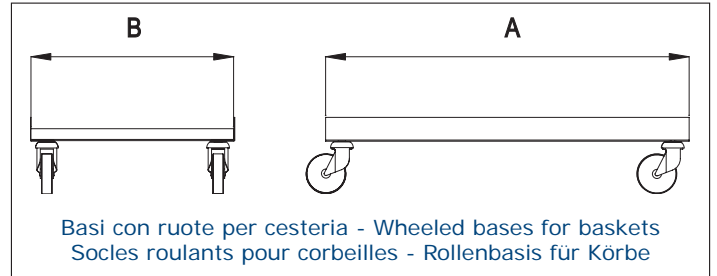

| CODICE - CODE CODE - KODEX | DETTAGLI - DETAILS - DETAILS - DETAIL | | Descrizione Description Description Beschreibung |
|-------------------------------|---|---|--|
| | Dimensioni Dimensions Dimensions Abmessungen (mm) | | |
| | A | B | |
| 10032332 | 320 x 350 | | basi verniciate color avorio bases ivory coated socles vernis ivoire lackierte eifennebeine Basis RAL 1013 ruote - wheels roues - Rollen Ø 80 |
| 10032342 | 320 x 400 | | |
| 10032352 | 320 x 500 | | |
| 10032362 | 320 x 600 | | |
| 10048332 | 480 x 350 | | basi verniciate color avorio bases ivory coated socles vernis ivoire lackierte eifennebeine Basis RAL 1013 ruote - wheels roues - Rollen Ø 80 |
| 10048342 | 480 x 400 | | |
| 10048352 | 480 x 500 | | |
| 10048362 | 480 x 600 | | |
| 10064343 | 640 x 400 per cesto - for basket - pour corbeille - für Korb H 300 | | basi verniciate color avorio bases ivory coated socles vernis ivoire lackierte eifennebeine Basis RAL 1013 ruote - wheels roues - Rollen Ø 100 |
| 10064344 | 640 x 400 per cesto - for basket - pour corbeille - für Korb H 400 | | |
| 10064353 | 640 x 500 per cesto - for basket - pour corbeille - für Korb H 300 | | |
| 10064354 | 640 x 500 per cesto - for basket - pour corbeille - für Korb H 400 | | |
| 10064363 | 640 x 600 per cesto - for basket - pour corbeille - für Korb H 300 | | |
| 10064364 | 640 x 600 per cesto - for basket - pour corbeille - für Korb H 400 | | |
| 10064374 | 640 x 700 per cesto - for basket - pour corbeille - für Korb H 400 | | |
| 10064384 | 640 x 800 per cesto - for basket - pour corbeille - für Korb H 400 | | |
| 10095343 | 950 x 400 per cesto - for basket - pour corbeille - für Korb H 300 | | |
| 10095344 | 950 x 400 per cesto - for basket - pour corbeille - für Korb H 400 | | |
| 10095353 | 950 x 500 per cesto - for basket - pour corbeille - für Korb H 300 | | |
| 10095354 | 950 x 500 per cesto - for basket - pour corbeille - für Korb H 400 | | |
| 10095363 | 950 x 600 per cesto - for basket - pour corbeille - für Korb H 300 | | |
| 10095364 | 950 x 600 per cesto - for basket - pour corbeille - für Korb H 400 | | |
| 10095374 | 950 x 700 per cesto - for basket - pour corbeille - für Korb H 400 | | |
| 10095384 | 950 x 800 per cesto - for basket - pour corbeille - für Korb H 400 | | |

| CODICE - CODE CODE - KODEX | DETTAGLI - DETAILS - DETAILS - DETAIL | | Descrizione Description Description Beschreibung |
|-------------------------------|--|---|--|
| | Dimensioni Dimensions Dimensions Abmessungen (mm) | | |
| | A | B | |
| 10099343 | 990 x 400 per cesto - for basket - pour corbeille - für Korb H 300 | | basi verniciate color avorio bases ivory coated socles vernis ivoire lackierte eifennebeine Basis RAL 1013 ruote - wheels roues - Rollen Ø 100 |
| 10099344 | 990 x 400 per cesto - for basket - pour corbeille - für Korb H 400 | | |
| 10099353 | 990 x 500 per cesto - for basket - pour corbeille - für Korb H 300 | | |
| 10099354 | 990 x 500 per cesto - for basket - pour corbeille - für Korb H 400 | | |
| 10099363 | 990 x 600 per cesto - for basket - pour corbeille - für Korb H 300 | | |
| 10099364 | 990 x 600 per cesto - for basket - pour corbeille - für Korb H 400 | | |
| 10099374 | 990 x 700 per cesto - for basket - pour corbeille - für Korb H 400 | | |
| 10099384 | 990 x 800 per cesto - for basket - pour corbeille - für Korb H 400 | | |
| 10125343 | 1250 x 400 per cesto - for basket - pour corbeille - für Korb H 300 | | |
| 10125344 | 1250 x 400 per cesto - for basket - pour corbeille - für Korb H 400 | | |
| 10125353 | 1250 x 500 per cesto - for basket - pour corbeille - für Korb H 300 | | |
| 10125354 | 1250 x 500 per cesto - for basket - pour corbeille - für Korb H 400 | | |
| 10125363 | 1250 x 600 per cesto - for basket - pour corbeille - für Korb H 300 | | |
| 10125364 | 1250 x 600 per cesto - for basket - pour corbeille - für Korb H 400 | | |
| 10125374 | 1250 x 700 per cesto - for basket - pour corbeille - für Korb H 400 | | |
| 10125384 | 1250 x 800 per cesto - for basket - pour corbeille - für Korb H 400 | | |
| 10132344 | 1320 x 400 per cesto - for basket - pour corbeille - für Korb H 400 | | basi verniciate color avorio bases ivory coated socles vernis ivoire lackierte eifennebeine Basis RAL 1013 ruote - wheels roues - Rollen Ø 80 |
| 10132354 | 1320 x 500 per cesto - for basket - pour corbeille - für Korb H 400 | | |
| 10132364 | 1320 x 600 per cesto - for basket - pour corbeille - für Korb H 400 | | |
| 10132374 | 1320 x 700 per cesto - for basket - pour corbeille - für Korb H 400 | | |
| 10132384 | 1320 x 800 per cesto - for basket - pour corbeille - für Korb H 400 | | |

TUTTE LE MISURE SONO ESPRESSE IN mm / ALL MEASUREMENTS IN mm / TOUTES MESURES EN mm / ALLE MABE IN mm

APPLICAZIONI PIEDI PER CESTI

FEET ASSEMBLING FOR BASKETS
 ASSEMBLAGE PIEDS POUR CORBEILLES
 FÜSSE-EINBAU FÜR KÖRBE



APPLICAZIONI RUOTE PER CESTI

WHEELS ASSEMBLING FOR BASKETS
 ASSEMBLAGE ROUES POUR CORBEILLES
 ROLLEN-EINBAU FÜR KÖRBE



| CODICE - CODE CODE - KODEX | | DETTAGLI - DETAILS - DETAILS - DETAIL | | CODICE - CODE CODE - KODEX | | DETTAGLI - DETAILS - DETAILS - DETAIL | |
|-------------------------------|---|---|--|-------------------------------|---|---|--|
| | | Dimensioni Dimensions Dimensions Abmessungen (mm) | Descrizione Description Description Beschreibung | | | Dimensioni Dimensions Dimensions Abmessungen (mm) | Descrizione Description Description Beschreibung |
| 10000632 | per cesti leggeri - for light baskets pour corbeilles légères für leichte Körbe | 350 x 250 H | applicazioni piedi zincate galvanized feet assembling assemblage pieds zingué Einbau verzinkte Füße | 10000532 | per cesti leggeri - for light baskets pour corbeilles légères für leichte Körbe | 350 x 250 H | applicazioni ruote zincate - galvanized wheels assembling assemblage roues zingué - Einbau verzinkte Rollen |
| 10000642 | per cesti leggeri - for light baskets pour corbeilles légères für leichte Körbe | 400 x 250/300/400 H | | 10000542 | per cesti leggeri - for light baskets pour corbeilles légères für leichte Körbe | 400 x 250/300/400 H | |
| 10000652 | per cesti leggeri - for light baskets pour corbeilles légères für leichte Körbe | 500 x 250/300/400 H | | 10000552 | per cesti leggeri - for light baskets pour corbeilles légères für leichte Körbe | 500 x 250/300/400 H | |
| 10000662 | per cesti leggeri - for light baskets pour corbeilles légères für leichte Körbe | 600 x 250/300/400 H | | 10000562 | per cesti leggeri - for light baskets pour corbeilles légères für leichte Körbe | 600 x 250/300/400 H | |
| 10000644 | per cesti pesanti - for heavy baskets pour corbeilles lourdes für schwere Körbe | 400 x 300/400 H | | 10000544 | per cesti pesanti - for heavy baskets pour corbeilles lourdes für schwere Körbe | 400 x 300/400 H | |
| 10000654 | per cesti pesanti - for heavy baskets pour corbeilles lourdes für schwere Körbe (640 x 400 x 300) | 500 x 300/400 H | | 10000554 | per cesti pesanti - for heavy baskets pour corbeilles lourdes für schwere Körbe (640 x 400 x 300) | 500 x 300/400 H | |
| 10000664 | per cesti pesanti - for heavy baskets pour corbeilles lourdes - für schwere Körbe (960-1050-1280 x 500 x 350) | 600 x 300/400 H | | 10000564 | per cesti pesanti - for heavy baskets pour corbeilles lourdes - für schwere Körbe (960-1050-1280 x 500 x 350) | 600 x 300/400 H | |
| 10000674 | per cesti pesanti - for heavy baskets pour corbeilles lourdes für schwere Körbe | 700 x 400 H | | 10000574 | per cesti pesanti - for heavy baskets pour corbeilles lourdes für schwere Körbe | 700 x 400 H | |
| 10000684 | per cesti pesanti - for heavy baskets pour corbeilles lourdes - für schwere Körbe (960-1050-1280 x 700 x 450) | 800 x 400 H | | 10000584 | per cesti pesanti - for heavy baskets pour corbeilles lourdes - für schwere Körbe (960-1050-1280 x 700 x 450) | 800 x 400 H | |
| | | | | | | | |
| | | | | | | | ruote - wheels - roues - Rollen Ø 100 |

TUTTE LE MISURE SONO ESPRESSE IN mm / ALL MEASUREMENTS IN mm / TOUTES MESURES EN mm / ALLE MAßE IN mm

ACCESSORI - ACCESSORIES - ACCESSOIRES - ZUBEHÖRE

CESTI SOVRAPPONIBILI
STACKABLE BASKETS
CORBEILLES EMPILABLES
STAPELBARE KÖRBE

DIVISORI - PARTITIONS - SEPARATEURS - TRENNGITTER

| CODICE CODE CODE KODEX | DETTAGLI - DETAILS DETAILS - DETAIL (mm) |
|---------------------------------|--|
| 10000132 | 350 x 250 H |
| 10000142 | 400 x 250 H |
| 10000152 | 500 x 250 H |
| 10000162 | 600 x 250 H |
| 10000144 | 400 x 350 H |
| 10000154 | 500 x 350 H |
| 10000164 | 600 x 350 H |
| 10000174 | 700 x 350 H |
| 10000184 | 800 x 350 H |
| 659156 | clips attacco divisorio nylon H 350: 3 per divisorio nylon clip for partition H 350: 3 each partition clip en nylon pour séparateur H 350: 3 chaque séparateur Nylon Klipp für Trenngitter H 350: 3 jedem Trenngitter |

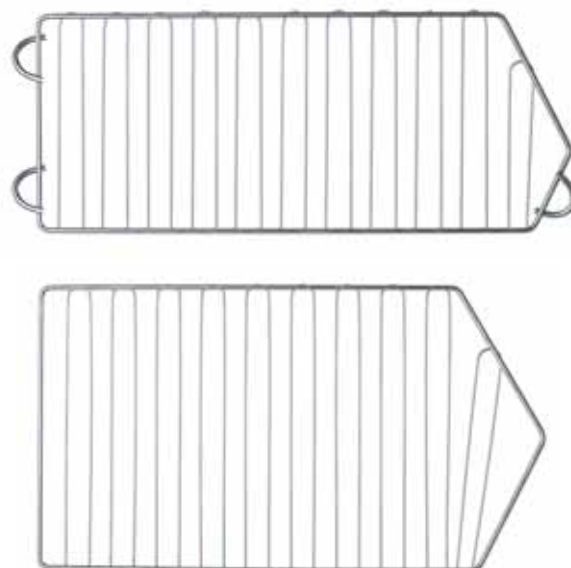

PORTA PREZZO - PRICE HOLDERS - PORTE ETIQUETTE - PREISTAFELN

| CODICE CODE CODE KODEX | DETTAGLI - DETAILS DETAILS - DETAIL (mm) |
|---------------------------------|--|
| 15001101 | 120 x 40 |
| 15001102 | 170 x 80 |
| 15003203 | 1400 numeri assortiti set of little numbers (1400 pcs) série de chiffres (1400 pcs) Serie mit assortierten Nummern (1400 Stk) |



ACCESSORI - ACCESSORIES - ACCESSOIRES - ZUBEHÖRE

CESTI IMBOTTIGLIABILI
INSERTABLE BASKETS
CORBEILLES EMBOUTEILLABLES
EINFÜGBARE KÖRBE

DIVISORI - PARTITIONS - SEPARATEURS - TRENNGITTER

SUPPORTI - SUPPORT - SUPPORT - HALTER

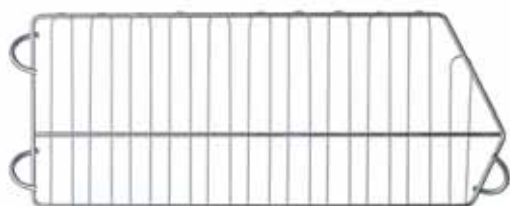

| CODICE CODE CODE KODEX | DETTAGLI - DETAILS DETAILS - DETAIL (mm) |
|---------------------------------|--|
| 10000243 | 400 x 300 H |
| 10000255 | 500 x 350 H |
| 10000275 | 700 x 450 H |

| CODICE CODE CODE KODEX | DETTAGLI - DETAILS DETAILS - DETAIL (mm) |
|---------------------------------|---|
| 609002 | supporti per cesto imbottigliabile: 4 ogni cesto support for insertable basket: 4 each basket support pour corbeille embouteillable: 4 chaque corbeille Halter für einfügbare Korb: 4 jedem Korb |

TUTTE LE MISURE SONO ESPRESSE IN mm / ALL MEASUREMENTS IN mm / TOUTES MESURES EN mm / ALLE MÄßE IN mm



CI RISERVIAMO IL DIRITTO DI PORTARE AI NOSTRI ARTICOLI QUALSIASI MODIFICA CHE GIUDICHEREMO UTILE SENZA PARERE PRELIMINARE

WE RESERVE OURSELVES THE RIGHT TO MODIFY OUR PRODUCTS WITHOUT GIVING PRIOR NOTICE

NOUS NOUS RÉSERVONS LE DROIT D'APPORTER À NOS ARTICLES TOUTES MODIFICATIONS QUE NOUS JUGERONS UTILES SANS AVIS PRÉALABLE

ÄNDERUNGEN VORBEHALTEN OHNE VORANKÜNDIGUNG